

ARTESYN LPS200-M SERIES

250 Watts (forced air)
150 Watts (convection)



PRODUCT DESCRIPTION

Advanced Energy’s Artesyn LPS200-M series power supplies are compact open-frame designs; measuring just 3 x 5 in, with a height of only 1.5 in, they have a typical full load efficiency of 88 % and a power density in excess of 11 watts per cubic inch. The supplies are primarily intended for use in information technology equipment (ITE) and light industrial systems, as well as for equipment intended for non-patient contact and non-patient critical use in low power medical, dental and laboratory applications.

The power supplies have a full load ambient operating temperature range of 0 to +50 degree Celsius without de-rating and can cold-start from temperatures as low as -20 degrees Celsius. Between 50 and 70 degrees Celsius, the output should be derated by 2.5 percent per degree.

SPECIAL FEATURES

- Medical and ITE safeties
- Active power factor correction
- 3” x 5” footprint
- Less than 1U high
- EN61000-3-2 compliant
- Remote sense
- Power fail
- Adjustable main output
- Built-in Class B EMI filter
- Overvoltage protection
- Overload protection
- Thermal overload protection
- Isolated 12 V Fan output
- LPX200 enclosure kit available

SAFETY

- TUV 62368,60601-1
- UL 62368,60601-1
- cULus 62368,60601-1
- CB Certificate & report
- CE Mark (LVD)

TYPICAL APPLICATIONS

- ITE
- Medical

AT A GLANCE

Total Power

150 to 250 Watts

Input Voltage

90 to 264 Vac

of Outputs

Single



MODEL NUMBERS

Model Number	Output Voltage	Minimum Load	Maximum Load with Convection Cooling	Maximum Load with 30CFM Forced Air	Peak Load ¹	Regulation ²	Ripple P/P ³
LPS202-M	5V	0A	20A	40A	44A	±2%	50mV
LPS203-M	12V	0A	10.3A	20.8A	22A	±2%	120mV
LPS204-M	15V	0A	8.3A	16.6A	18A	±2%	150mV
LPS205-M	24V	0A	5.2A	10.4A	11.5A	±2%	240mV
LPS208-M	48V	0A	2.6A	5.2A	5.8A	±2%	480mV

Note 1 - Peak current lasting <30seconds with a maximum 10% duty cycle.
 Note 2 - At 25°C including initial tolerance, line voltage, load currents and output voltages adjusted to factory settings.
 Note 3 - Peak-to-peak with 20MHz bandwidth and 10uF (tantalum capacitor) in parallel with a 0.1uF capacitor at rated line voltage and load ranges.

Options

None

ELECTRICAL SPECIFICATIONS

Absolute Maximum Ratings

Stress in excess of those listed in the “Absolute Maximum Ratings” may cause permanent damage to the power supply. These are stress ratings only and functional operation of the unit is not implied at these or any other conditions above those given in the operational sections of this TRN. Exposure to any absolute maximum rated condition for extended periods may adversely affect the power supply’s reliability.

Table 1. Absolute Maximum Ratings							
Parameter	Model	Symbol	Min	Typ	Max	Unit	
Input Voltage	AC continuous operation	All models	$V_{IN,AC}$	90	-	264	Vac
	DC continuous operation	All models	$V_{IN,DC}$	120	-	300	Vdc
Maximum Output Power (Main+Fan) Convection continuous operation	LPS202-M	$P_{O,maxCC}$	-	-	100	W	
	LPS203-M		-	-	125		
	LPS204-M		-	-	125		
	LPS205-M		-	-	125		
	LPS208-M		-	-	125		
Maximum Output Power (Main+Fan) Force air continuous operation-30CFM	LPS202-M	$P_{O,maxFA}$	-	-	200	W	
	LPS203-M		-	-	250		
	LPS204-M		-	-	250		
	LPS205-M		-	-	250		
	LPS208-M		-	-	250		
Isolation Voltage	Input to outputs	All models	-	-	4000	Vac	
	Input to safety ground	All models	-	-	1500	Vac	
	Output to output Isolation	All models	-	-	100	Vdc	
	Outputs to safety ground	All models	-	-	500	Vac	
Ambient Operating Temperature	All models	T_A	0	-	+70 ¹	°C	
Cold Start-up Temperature	All models	T_{ST}	-20	-	-	°C	
Storage Temperature	All models	T_{STG}	-40	-	+85	°C	
Humidity (non-condensing)	Operating	All models	10	-	90	%	
	Non-operating	All models	10	-	95	%	
Altitude	Operating	All models	-500	-	13,000 ²	feet	
	Non-operating	All models	-1000	-	50,000	feet	

Note 1 - Derate each output at 2.5% per degree C from 50°C to 70°C.

Note 2 - Derate maximum operating temperature by 1°C per 1,000 feet above 13,000 feet.

ELECTRICAL SPECIFICATIONS

Input Specifications

Table 2. Input Specifications						
Parameter	Condition	Symbol	Min	Typ	Max	Unit
Operating Input Voltage, AC	All	$V_{IN,AC}$	90	-	264	Vac
Input AC Source Frequency	All	$f_{IN,AC}$	47	-	63	Hz
Operating Input Voltage, DC	All	$V_{IN,DC}$	120		300	V_{DC}
Maximum Input Current ($I_O = I_{O,max}$)	$V_{IN,AC} = 90Vac$ $V_{IN,AC} = 264Vac$	$I_{IN,max}$	-	-	3.5 1.5	A_{RMS}
No Load Input Power	All	P_{IN}	-	-	10	W
No Load Input Current	$V_{IN,AC} = 90Vac$ $V_{IN,AC} = 264Vac$	I_{IN,no_load}	-	-	250 150	mA_{RMS}
Harmonic Line Currents	All	THD	Per EN61000-3-2			
Power Factor	All		-	0.99	-	
Startup Surge Current (Inrush) @ 25°C	$V_{IN,AC} = 230Vac$ Cold start		-	-	50	A_{PK}
Input AC Low Line Start-up Voltage	$I_O = 0$	$V_{IN,AC-start}$	84	-	89	Vac
Input AC Under Voltage Lockout Voltage	$I_O = 0$	$V_{IN,AC-stop}$	70	-	80	Vac
Input DC Low Line Start-up Voltage	$I_O = 0$	$V_{IN,DC-start}$	110	-	119	Vdc
Input DC Under Voltage Lockout Voltage	$I_O = 0$	$V_{IN,DC-stop}$	102	-	109	Vdc
PFC Switching Frequency	$V_{IN,AC} = 180Vac$	$f_{SW,PFC}$	30	-	68	KHz
DCDC Switching Frequency	All	$f_{SW,DC-DC}$	260	-	300	KHz
Operating Efficiency @ 25°C	$I_O = I_{O,max}$ $V_{IN,AC} = 100Vac$	η	-	86	-	%
Hold Up Time	$V_{IN,AC}=115Vac$	$t_{Hold-Up}$	16	-	-	mSec
Turn On Delay	$V_{IN,AC}=90Vac$	$t_{Turn-on}$	-	-	2	Sec
Leakage Current to safety ground	$V_{IN}=264Vac, f_{IN}=50/60Hz$	$I_{IN,leakage}$	-	-	275	μA
System Stability:						
	Phase Margin	330 $\mu F/A$	45	-	-	ϕ
	Gain Margin	Capacitive Load	10	-	-	dB

ELECTRICAL SPECIFICATIONS

Output Specifications

Table 3. Output Specifications							
Parameter		Condition	Symbol	Min	Typ	Max	Unit
Output Regulation	LPS202-M LPS203-M LPS204-M LPS205-M LPS208-M	$V_O=90\sim 264V_{ac}$	V_O	4.90	5.00	5.10	V
	11.76			12.00	12.24		
	All models		V_{FAN}	11.4	12.0	12.6	
Output Ripple, pk-pk	LPS202-M LPS203-M LPS204-M LPS205-M LPS208-M	Measure with a 0.1 μ F ceramic capacitor in parallel with a 10 μ F tantalum capacitor, 0 to 20MHz bandwidth	V_O	-	-	50.0	mV _{PK-PK}
	-			-	120.0		
	All models		V_{FAN}	-	-	120.0	
Output Current	LPS202-M LPS203-M LPS204-M LPS205-M LPS208-M	Convection Cooling	I_O	0	-	20.0	A
	0			-	10.3		
	All models		I_{FAN}	0	-	0.5	
Output Current	LPS202-M LPS203-M LPS204-M LPS205-M LPS208-M	30CFM Force Air	I_O	0	-	40.0	A
	0			-	20.8		
	All models		I_{FAN}	0	-	1.0	
Output Power	LPS202-M LPS203-M LPS204-M LPS205-M LPS208-M	$V_O=90\sim 264V_{ac}/$ 127~300Vdc Natural convection cooling	P_o	-	100	-	W
				-	125	-	
Output Power	LPS202-M LPS203-M LPS204-M LPS205-M LPS208-M	$V_O=90\sim 264V_{ac}/$ 127~300Vdc Lengthwise/Sideways Forced air cooling of 30CFM	P_o	-	200	-	W
				-	250	-	
V_O Load Capacitance		Start up Using CR load and capacitive load in parallel	-	0	-	330	mF/A
V_O Dynamic Response - Peak Deviation		50% load change (From 50% to 100%) Slew rate = 1A/us 100uF/A	$\pm\%V_O$	-	-	3	%
V_O Dynamic Response - Setting Time		50% load change (From 50% to 100%) Slew rate = 1A/us 100uF/A	T_s	-	-	500	uSec

ELECTRICAL SPECIFICATIONS

Output Specifications

Table 3. Output Specifications Con't							
Parameter		Condition	Symbol	Min	Typ	Max	Unit
Output Adjust Range	LPS202-M	$V_{IN,AC} = 115Vac$ $I_O = 50\%$ of $I_{O,maxFA}$ $I_{FAN} = 0$	V_O	4.5	-	5.5	V
	LPS203-M			10.8	-	13.2	
	LPS204-M			13.5	-	16.5	
	LPS205-M			21.6	-	26.4	
	LPS208-M			43.2	-	52.8	
V_O Turn On Overshoot	LPS202-M	$I_O = 0, I_{FAN} = 0$	V_O	-	-	5.15	V
	LPS203-M			-	-	12.36	
	LPS204-M			-	-	15.45	
	LPS205-M			-	-	24.72	
	LPS208-M			-	-	49.44	
V_O Long Term Stability		$I_O = \text{Full load}, V_O = 100Vac,$ Max change over 24 hours after thermal equilibrium	$\pm\%V_O$	-	-	1.0	%
V_O Over Voltage Protection		Latch off (AC recycle to reset)	$\%V_O$	130	-	150	%
V_O Over Current Protection		All	$\%I_O$	110	-	160	%
Over Temperature Protection		All		Auto Recovery			
Short Circuit Protection		All		Auto Recovery			
Remote Sense, + and -		Maximum compensation at each output line	V_{SENSE}	-	-	400	mV

ELECTRICAL SPECIFICATIONS

LPS202-M Performance Curves

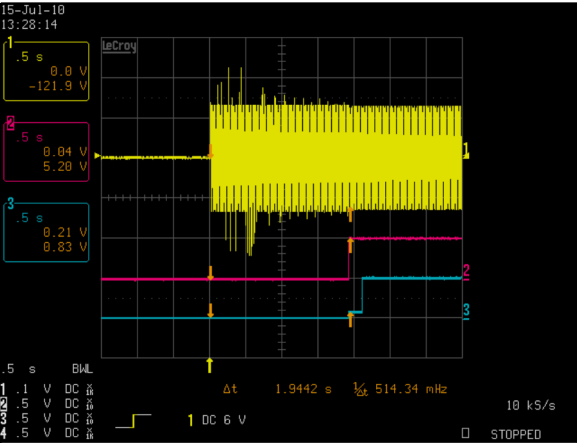

Figure 1: LPS202-M Turn-on delay
 Vin = 90Vac Load: Io = 40A, I_{FAN} = 0A
 Ch 1: V_{IN} Ch 2: V_O Ch 3: Power Fail

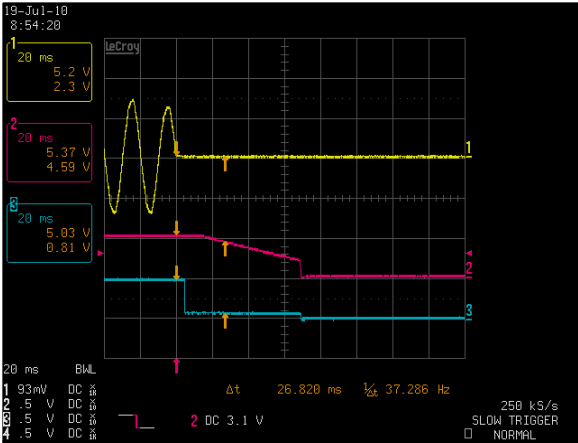

Figure 2: LPS202-M Hold-up Time
 Vin = 90Vac Load: Io = 40A, I_{FAN} = 0A
 Ch 1: V_{IN} Ch 2: V_O Ch 3: Power Fail

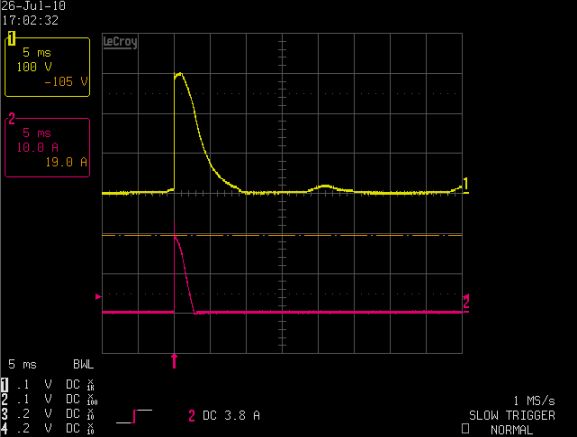

Figure 3: LPS202-M Inrush Current
 Vin = 230Vac Load: Io = 0A, I_{FAN} = 0A, Turn on at 90 deg
 Ch 1: V_{IN} Ch 2: I_{IN}

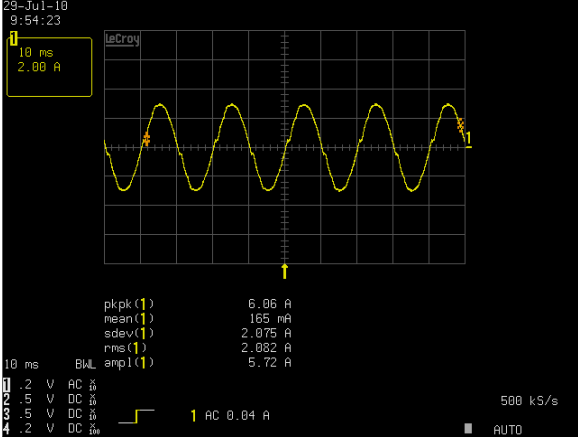

Figure 4: LPS202-M Input Current Waveform
 Vin = 115Vac Load: Io = 40A, I_{FAN} = 0A
 Ch 1: I_{IN}

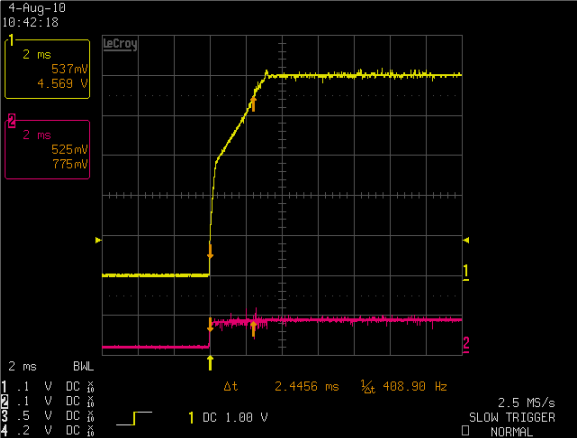

Figure 5: LPS202-M Output Voltage Startup Characteristic
 Vin = 90Vac Load: Io = 40A, I_{FAN} = 0A
 Ch 1: V_O Ch 2: Power Fail Output Capacitance = 330uF/A

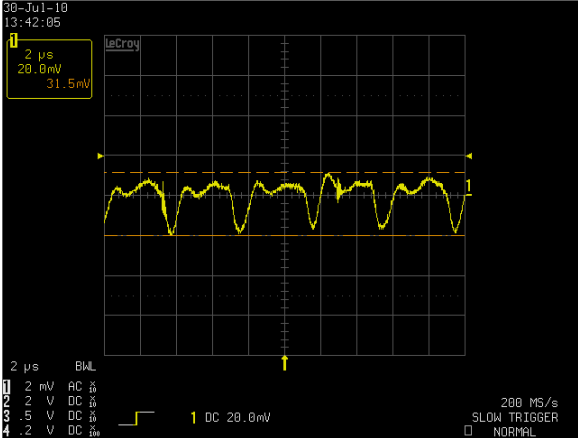

Figure 6: LPS202-M Ripple and Noise Measurement
 Vin = 115Vac Load: Io = 40A, I_{FAN} = 0A
 Ch 1: V_O

ELECTRICAL SPECIFICATIONS

LPS202-M Performance Curves

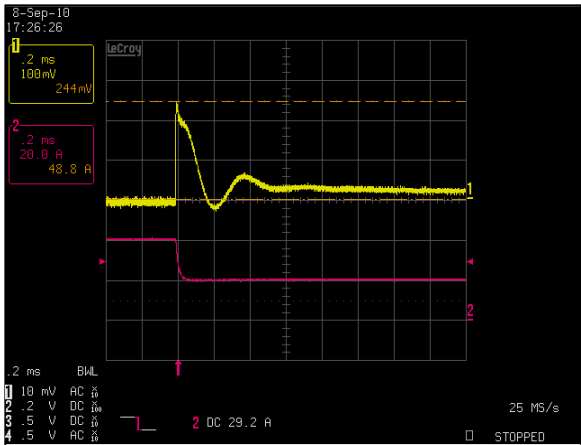

Figure 7: LPS202-M Transient Response – Vo Deviation
 Vin = 115Vac Load: Io = 100% to 50%, 1A/us slew rate
 Ch 1: Vo Ch 2: Io

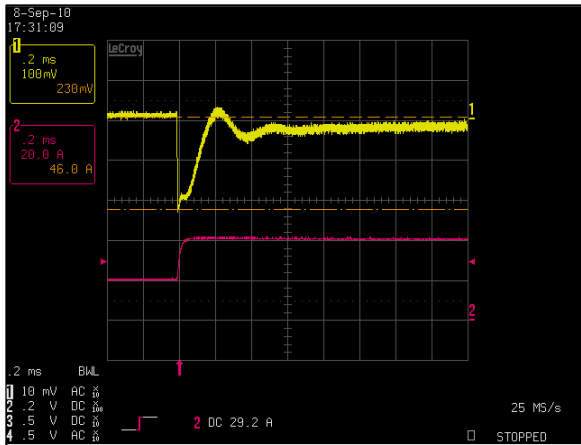

Figure 8: LPS202-M Transient Response – Vo Deviation
 Vin = 115Vac Load: Io = 50% to 100%, 1A/us slew rate
 Ch 1: Vo Ch 2: Io

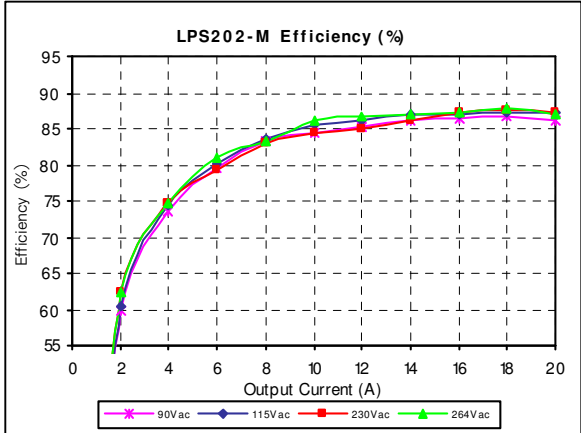

Figure 9: LPS202-M Efficiency Curves @ 25 degC
 Convection Cooling
 Vin = 90 to 264Vac Load: Io = 0 to 20A, IFAN = 0A

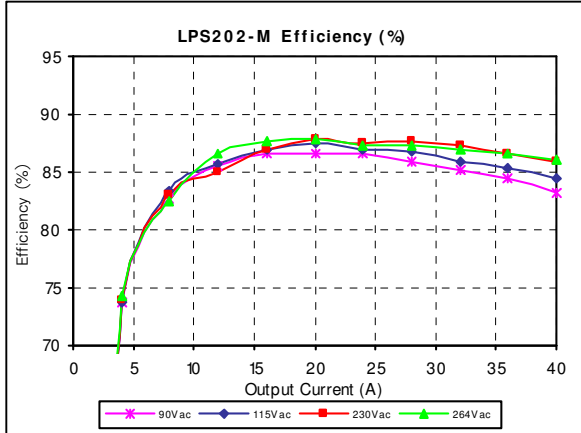

Figure 10: LPS202-M Efficiency Curves @ 25 degC
 30 CFM Forced Air
 Vin = 90 to 264Vac Load: Io = 0 to 40A, IFAN = 0A

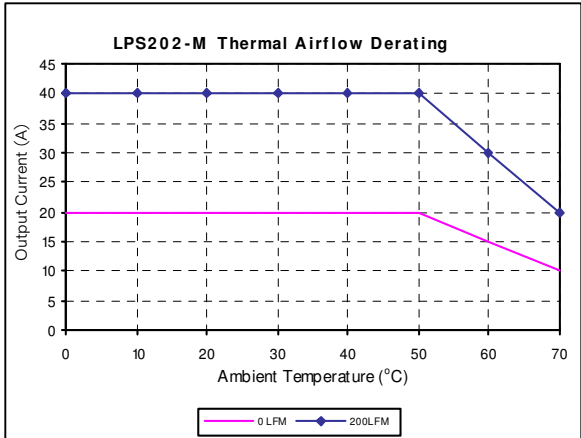

Figure 11: LPS202-M Derating Curves
 Vin = 115Vac Load: Io = 0 to 40A, IFAN = 0A

ELECTRICAL SPECIFICATIONS

LPS203-M Performance Curves

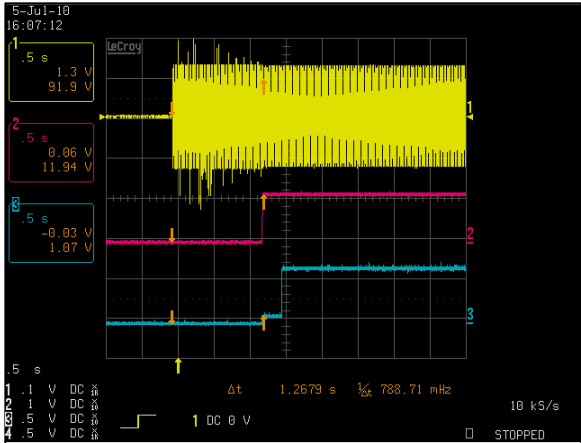

Figure 12: LPS203-M Turn-on delay
 Vin = 90Vac Load: Io = 20.8A, IFAN = 0A
 Ch 1: VIN Ch 2: Vo Ch 3: Power Fail

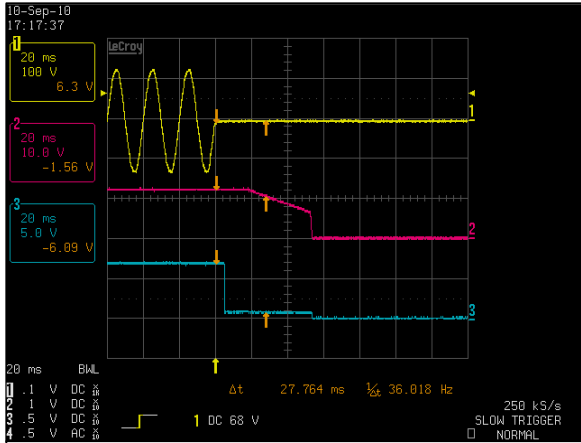

Figure 13: LPS203-M Hold-up Time
 Vin = 90Vac Load: Io = 20.8A, IFAN = 0A
 Ch 1: VIN Ch 2: Vo Ch 3: Power Fail

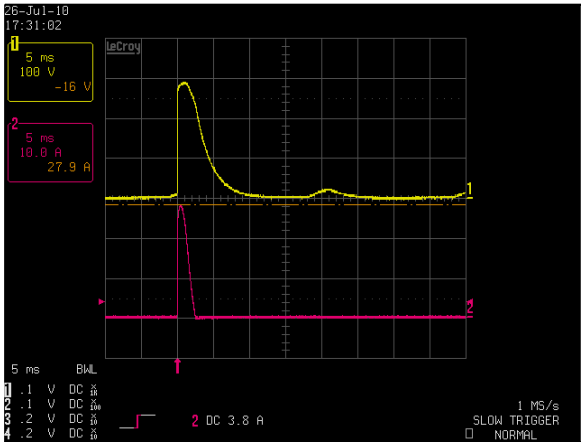

Figure 14: LPS203-M Inrush Current
 Vin = 230Vac Load: Io = 0A, IFAN = 0A, Turn on at 90 deg
 Ch 1: VIN Ch 2: IIN

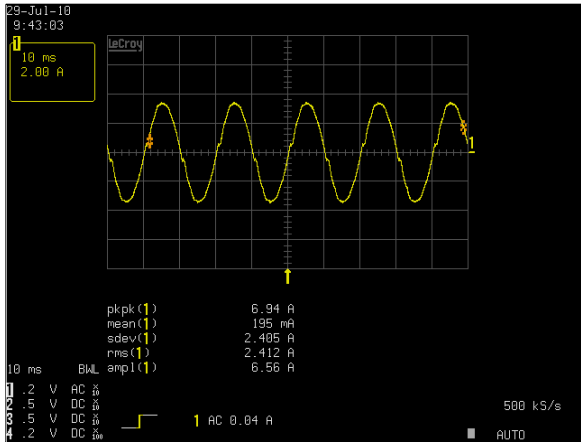

Figure 15: LPS203-M Input Current Waveform
 Vin = 115Vac Load: Io = 20.8A, IFAN = 0A
 Ch 1: IIN

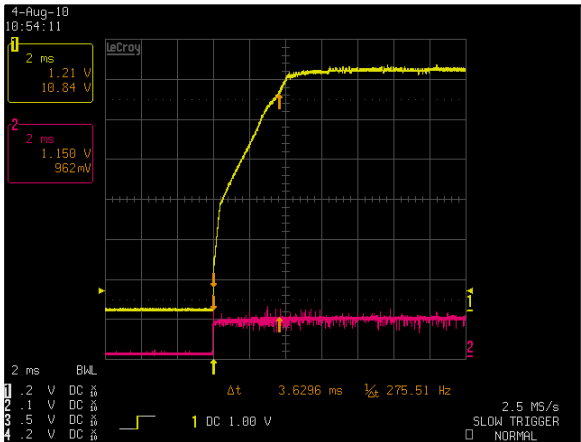

Figure 16: LPS203-M Output Voltage Startup Characteristic
 Vin = 90Vac Load: Io = 20.8A, IFAN = 0A
 Ch 1: Vo Ch 2: Power Fail Output Capacitance = 330uF/A

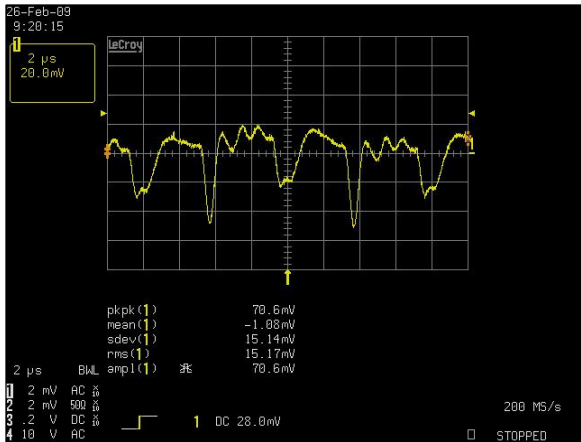

Figure 17: LPS203-M Ripple and Noise Measurement
 Vin = 115Vac Load: Io = 20.8A, IFAN = 0A
 Ch 1: Vo

ELECTRICAL SPECIFICATIONS

LPS203-M Performance Curves

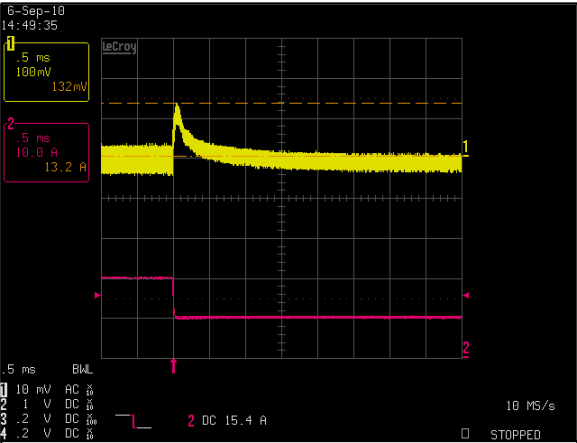

Figure 18: LPS203-M Transient Response – Vo Deviation
 Vin = 115Vac Load: Io = 100% to 50%, 1A/us slew rate
 Ch 1: Vo Ch 2: Io

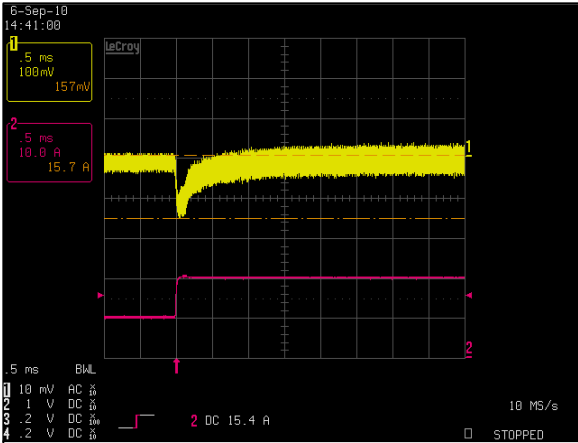

Figure 19: LPS203-M Transient Response – Vo Deviation
 Vin = 115Vac Load: Io = 50% to 100%, 1A/us slew rate
 Ch 1: Vo Ch 2: Io

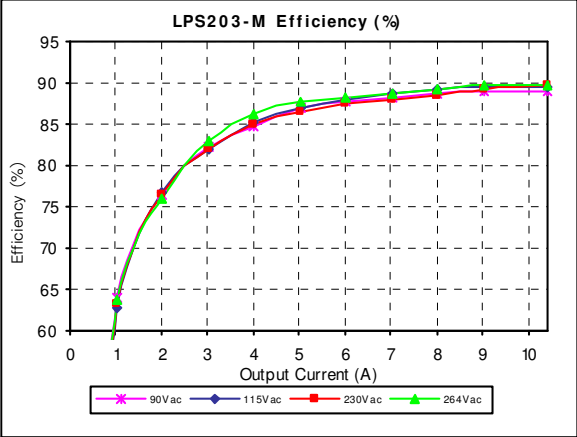

Figure 20: LPS203-M Efficiency Curves @ 25 degC
 Convection Cooling
 Vin = 90 to 264Vac Load: Io = 0 to 10.4A, I_{FAN} = 0A

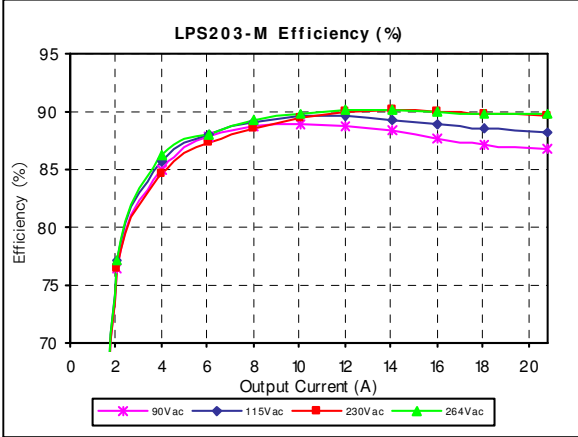

Figure 21: LPS203-M Efficiency Curves @ 25 degC
 30 CFM Forced Air
 Vin = 90 to 264Vac Load: Io = 0 to 20.8A, I_{FAN} = 0A

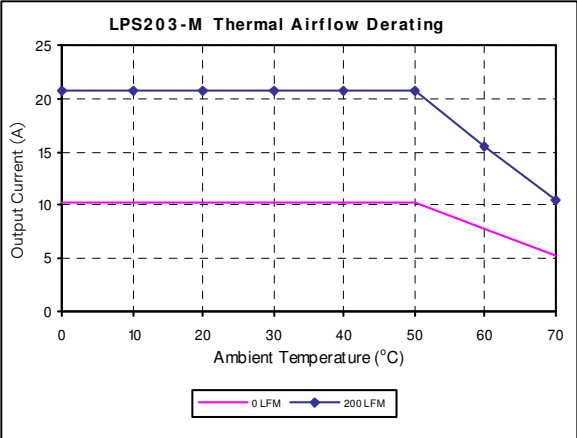

Figure 22: LPS203-M Derating Curves
 Vin = 115Vac Load: Io = 0 to 20.8A, I_{FAN} = 0A

ELECTRICAL SPECIFICATIONS

LPS204-M Performance Curves

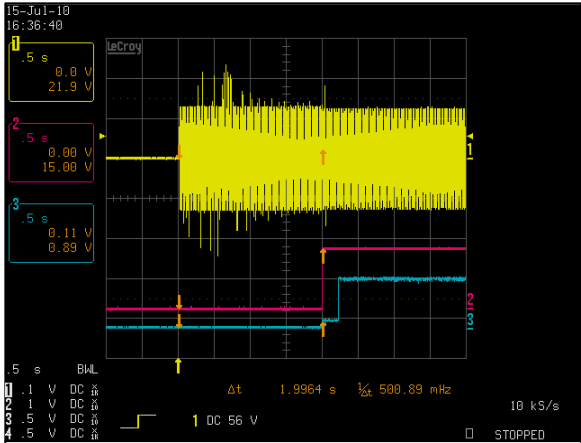

Figure 23: LPS204-M Turn-on delay
 Vin = 90Vac Load: Io = 16.6A, IFAN = 0A
 Ch 1: VIN Ch 2: Vo Ch 3: Power Fail

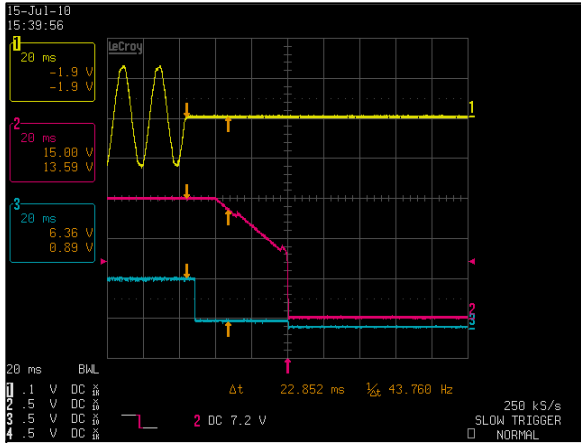

Figure 24: LPS204-M Hold-up Time
 Vin = 90Vac Load: Io = 16.6A, IFAN = 0A
 Ch 1: VIN Ch 2: Vo Ch 3: Power Fail

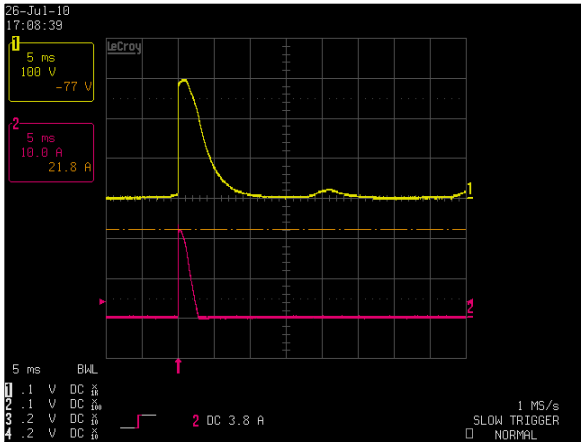

Figure 25: LPS204-M Inrush Current
 Vin = 230Vac Load: Io = 0A, IFAN = 0A, Turn on at 90 deg
 Ch 1: VIN Ch 2: IIN

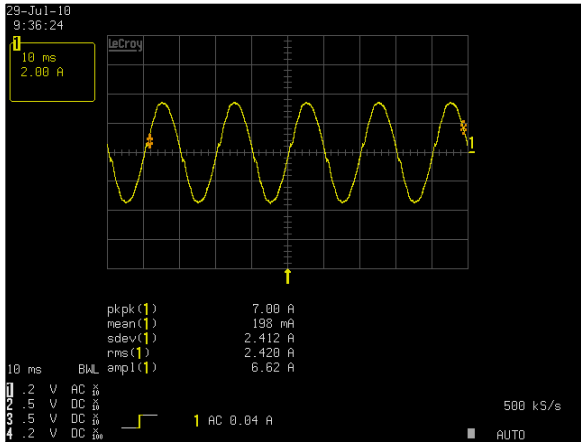

Figure 26: LPS204-M Input Current Waveform
 Vin = 115Vac Load: Io = 16.6A, IFAN = 0A
 Ch 1: IIN

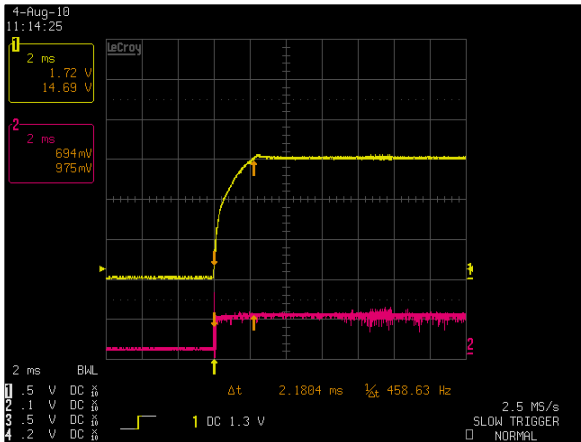

Figure 27: LPS204-M Output Voltage Startup Characteristic
 Vin = 90Vac Load: Io = 16.6A, IFAN = 0A
 Ch 1: Vo Ch 2: Power Fail Output Capacitance = 330uF/A

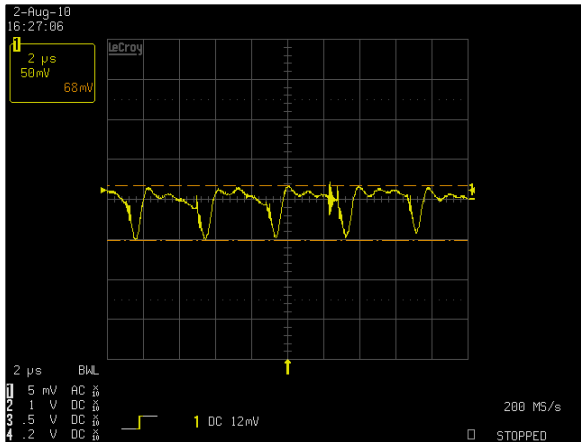

Figure 28: LPS204-M Ripple and Noise Measurement
 Vin = 115Vac Load: Io = 16.6A, IFAN = 0A
 Ch 1: Vo

ELECTRICAL SPECIFICATIONS

LPS204-M Performance Curves

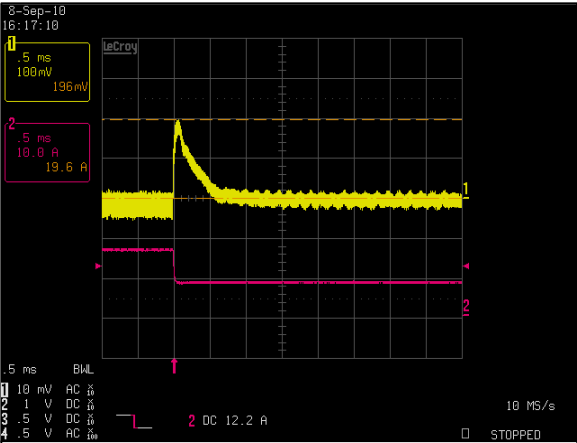

Figure 29: LPS204-M Transient Response – Vo Deviation
 Vin = 115Vac Load: Io = 100% to 50%, 1A/us slew rate
 Ch 1: Vo Ch 2: Io

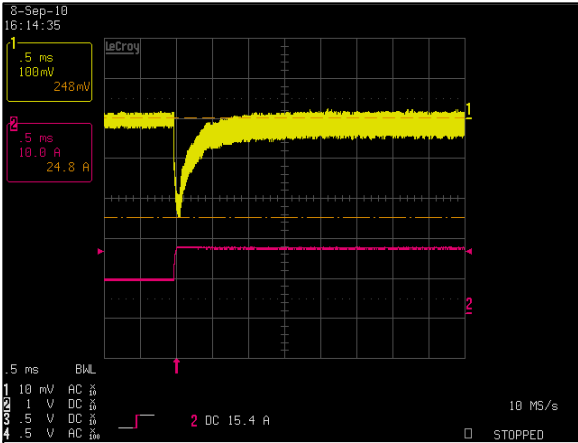

Figure 30: LPS204-M Transient Response – Vo Deviation
 Vin = 115Vac Load: Io = 50% to 100%, 1A/us slew rate
 Ch 1: Vo Ch 2: Io

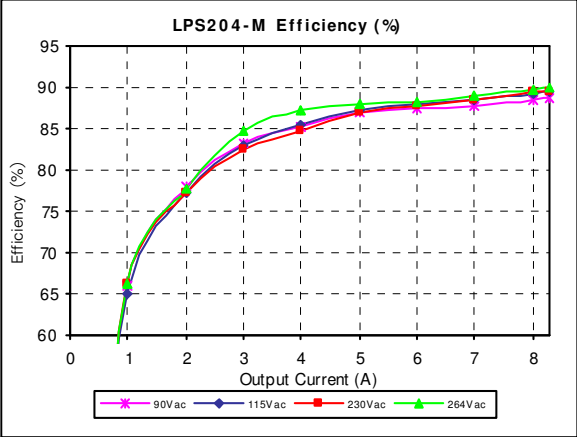

Figure 31: LPS204-M Efficiency Curves @ 25 degC
 Convection Cooling
 Vin = 90 to 264Vac Load: Io = 0 to 8.3A, IFAN = 0A

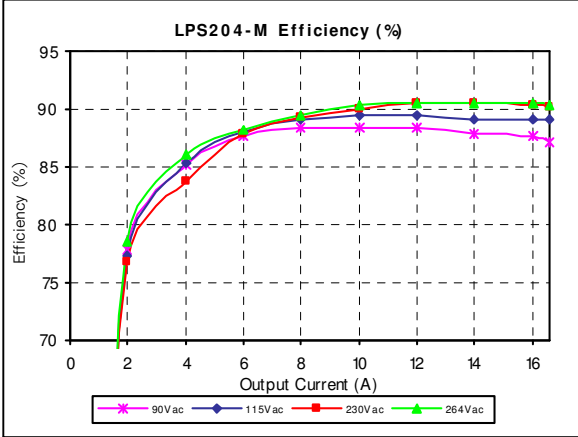

Figure 32: LPS204-M Efficiency Curves @ 25 degC
 30 CFM Forced Air
 Vin = 90 to 264Vac Load: Io = 0 to 16.6A, IFAN = 0A

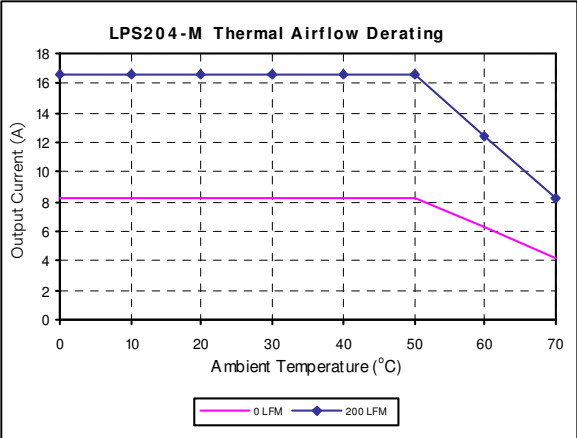

Figure 33: LPS204-M Derating Curves
 Vin = 115Vac Load: Io = 0 to 16.6A, IFAN = 0A

ELECTRICAL SPECIFICATIONS

LPS205-M Performance Curves

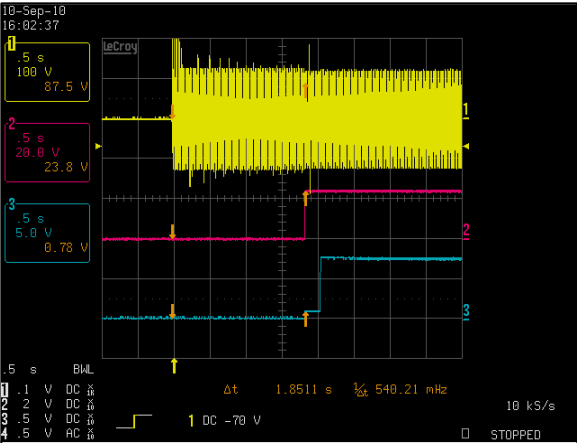

Figure 34: LPS205-M Turn-on delay
 Vin = 90Vac Load: Io = 10.4A, IFAN = 0A
 Ch 1: VIN Ch 2: Vo Ch 3: Power Fail

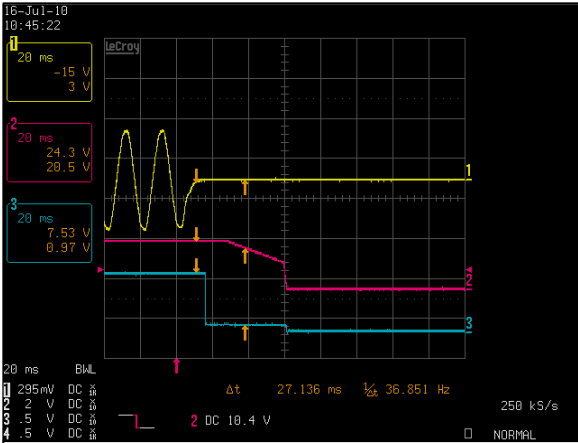

Figure 35: LPS205-M Hold-up Time
 Vin = 90Vac Load: Io = 10.4A, IFAN = 0A
 Ch 1: VIN Ch 2: Vo Ch 3: Power Fail

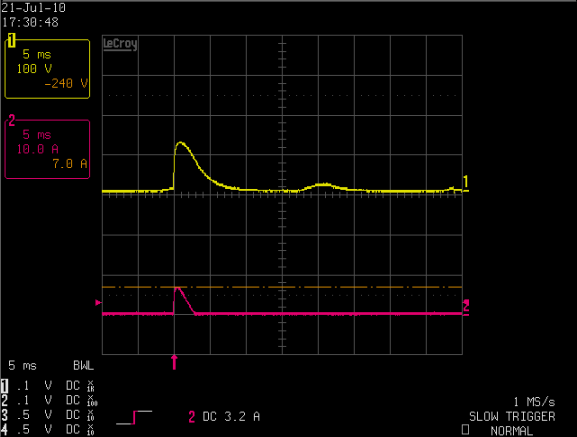

Figure 36: LPS205-M Inrush Current
 Vin = 230Vac Load: Io = 0A, IFAN = 0A, Turn on at 90 deg
 Ch 1: VIN Ch 2: IIN

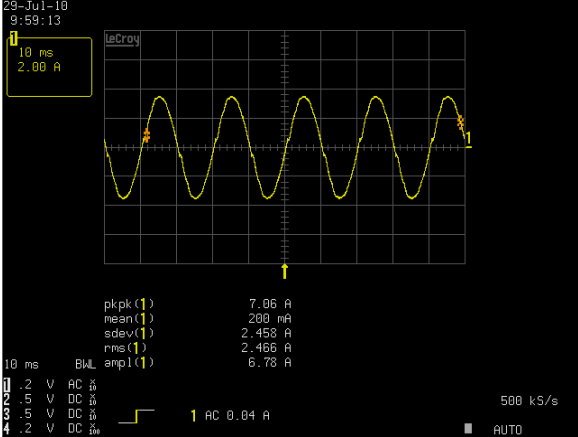

Figure 37: LPS205-M Input Current Waveform
 Vin = 115Vac Load: Io = 10.4A, IFAN = 0A
 Ch 1: IIN

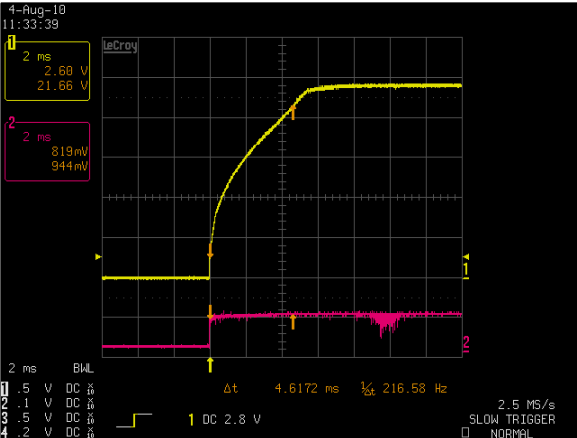

Figure 38: LPS205-M Output Voltage Startup Characteristic
 Vin = 90Vac Load: Io = 10.4A, IFAN = 0A
 Ch 1: Vo Ch 2: Power Fail Output Capacitance = 330uF/A

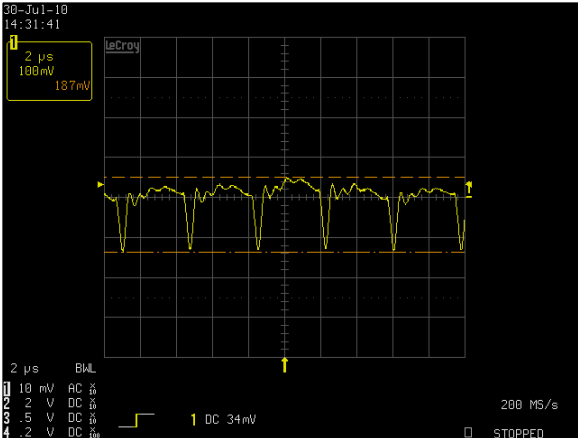

Figure 39: LPS205-M Ripple and Noise Measurement
 Vin = 115Vac Load: Io = 10.4A, IFAN = 0A
 Ch 1: Vo

ELECTRICAL SPECIFICATIONS

LPS205-M Performance Curves

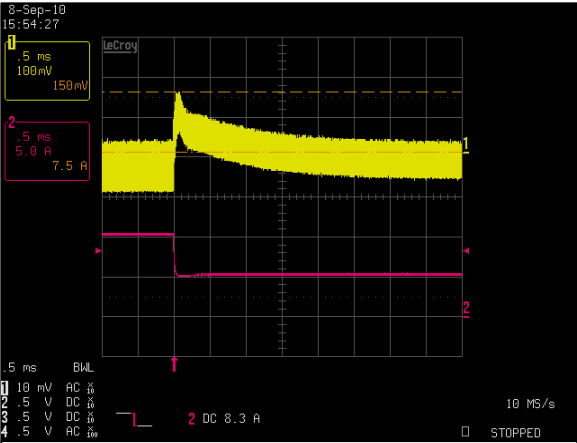

Figure 40: LPS205-M Transient Response – Vo Deviation
 Vin = 115Vac Load: Io = 100% to 50%, 1A/us slew rate
 Ch 1: Vo Ch 2: Io

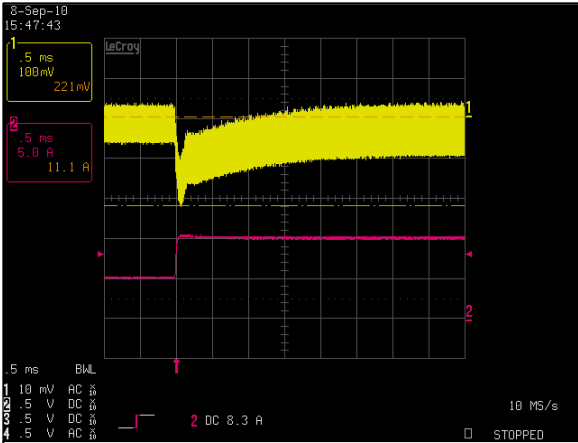

Figure 41: LPS205-M Transient Response – Vo Deviation
 Vin = 115Vac Load: Io = 50% to 100%, 1A/us slew rate
 Ch 1: Vo Ch 2: Io

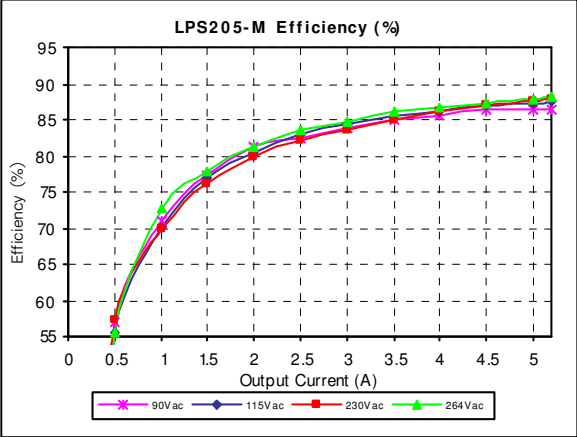

Figure 42: LPS205-M Efficiency Curves @ 25 degC
 Convection Cooling
 Vin = 90 to 264Vac Load: Io = 0 to 5.2A, IFAN = 0A

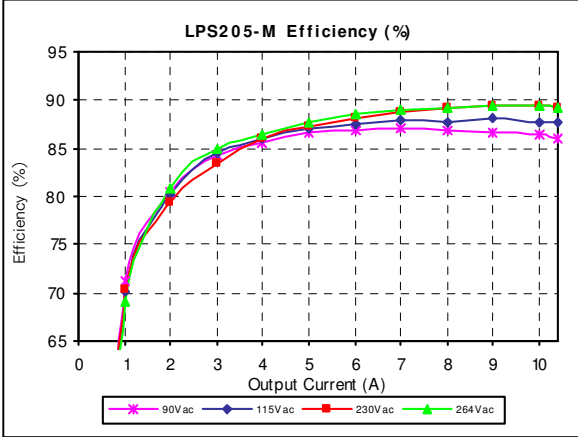

Figure 43: LPS205-M Efficiency Curves @ 25 degC
 30 CFM Forced Air
 Vin = 90 to 264Vac Load: Io = 0 to 10.4A, IFAN = 0A

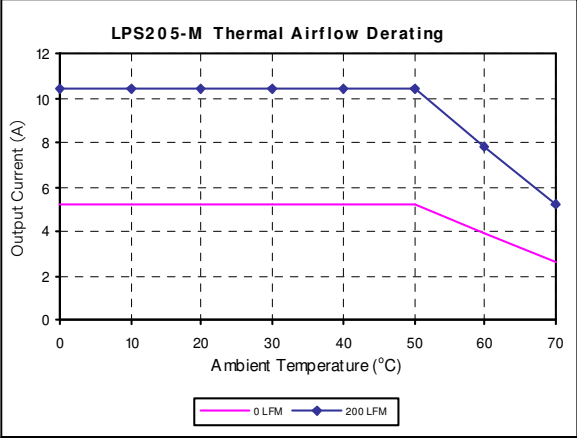

Figure 44: LPS205-M Derating Curves
 Vin = 115Vac Load: Io = 0 to 10.4A, IFAN = 0A

ELECTRICAL SPECIFICATIONS

LPS208-M Performance Curves

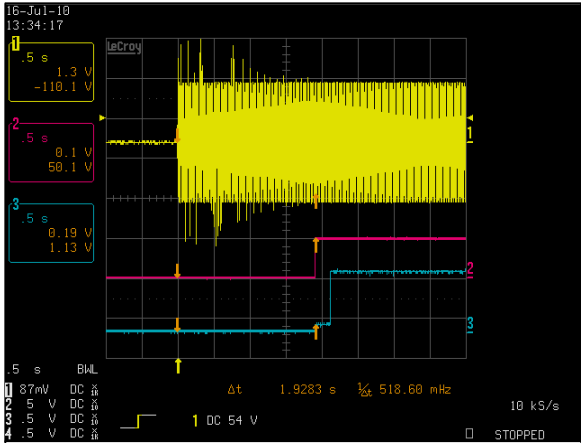

Figure 45: LPS208-M Turn-on delay
 Vin = 90Vac Load: Io = 5.2A, IFAN = 0A
 Ch 1: V_{IN} Ch 2: V_O Ch 3: Power Fail

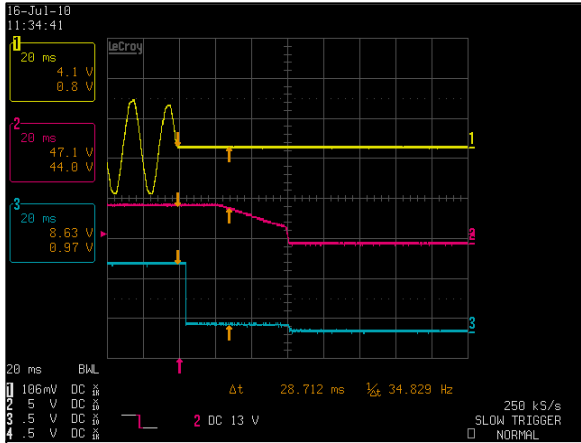

Figure 46: LPS208-M Hold-up Time
 Vin = 90Vac Load: Io = 5.2A, IFAN = 0A
 Ch 1: V_{IN} Ch 2: V_O Ch 3: Power Fail

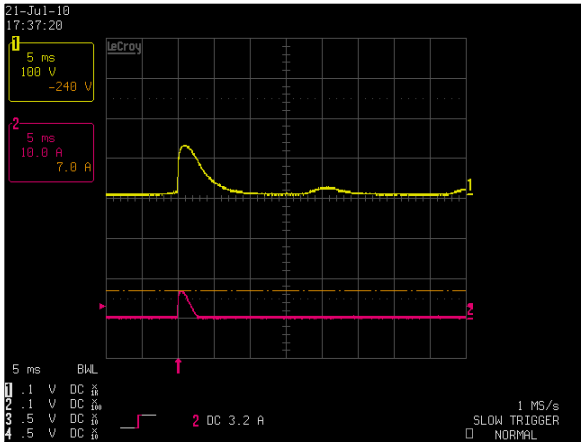

Figure 47: LPS208-M Inrush Current
 Vin = 230Vac Load: Io = 0A, IFAN = 0A, Turn on at 90 deg
 Ch 1: V_{IN} Ch 2: I_{IN}

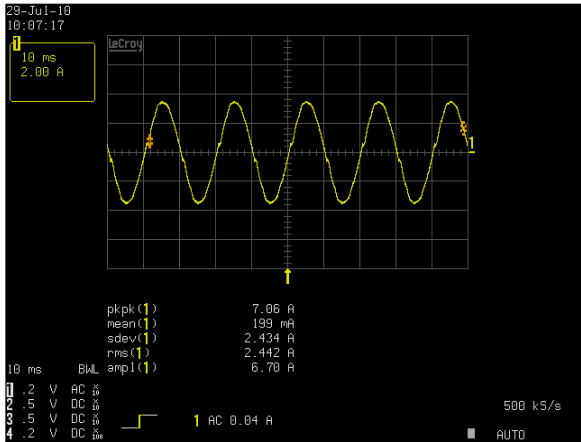

Figure 48: LPS208-M Input Current Waveform
 Vin = 115Vac Load: Io = 5.2A, IFAN = 0A
 Ch 1: I_{IN}

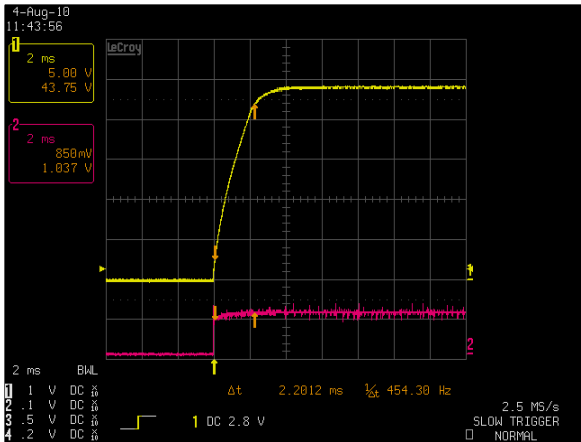

Figure 49: LPS208-M Output Voltage Startup Characteristic
 Vin = 90Vac Load: Io = 5.2A, IFAN = 0A
 Ch 1: V_O Ch 2: Power Fail Output Capacitance = 330uF/A

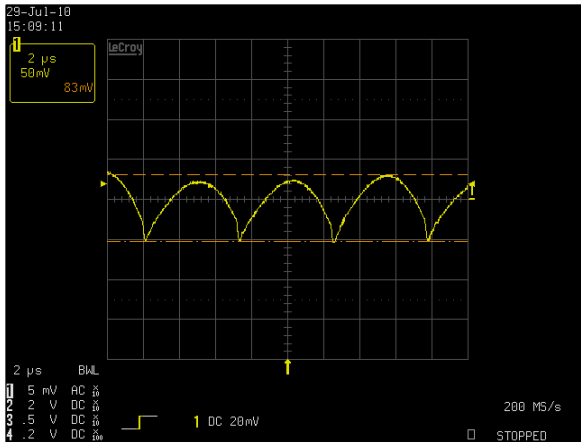

Figure 50: LPS208-M Ripple and Noise Measurement
 Vin = 115Vac Load: Io = 5.2A, IFAN = 0A
 Ch 1: V_O

ELECTRICAL SPECIFICATIONS

LPS208-M Performance Curves

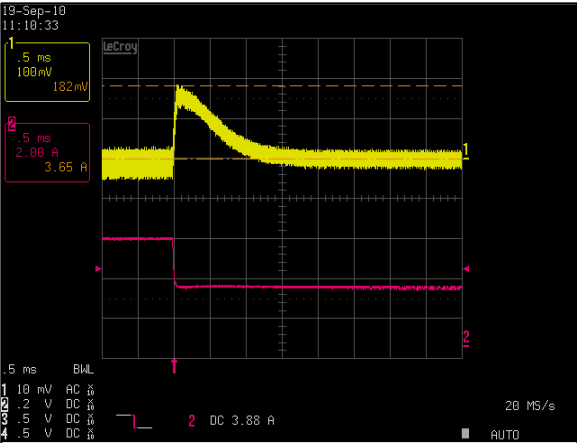

Figure 51: LPS208-M Transient Response – Vo Deviation
 Vin = 115Vac Load: Io = 100% to 50%, 1A/us slew rate
 Ch 1: Vo Ch 2: Io

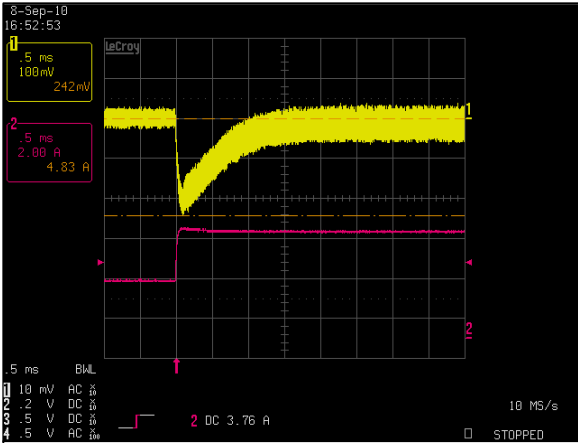

Figure 52: LPS208-M Transient Response – Vo Deviation
 Vin = 115Vac Load: Io = 50% to 100%, 1A/us slew rate
 Ch 1: Vo Ch 2: Io

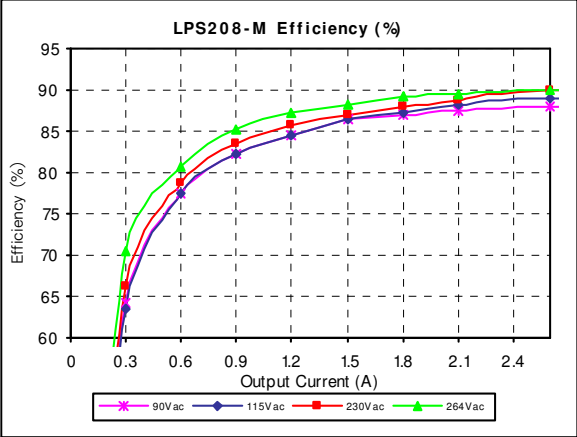

Figure 53: LPS208-M Efficiency Curves @ 25 degC
 Convection Cooling
 Vin = 90 to 264Vac Load: Io = 0 to 2.6A, I_{FAN} = 0A

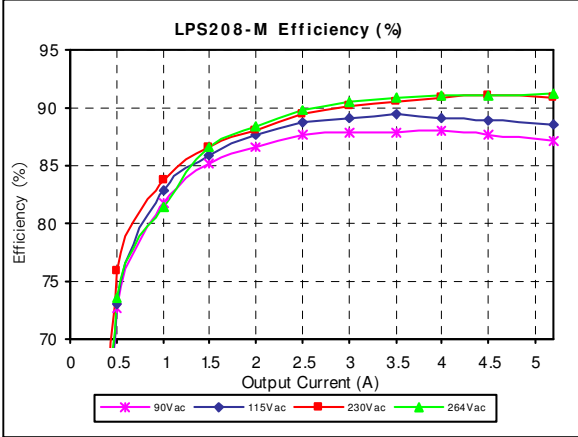

Figure 54: LPS208-M Efficiency Curves @ 25 degC
 30 CFM Forced Air
 Vin = 90 to 264Vac Load: Io = 0 to 5.2A, I_{FAN} = 0A

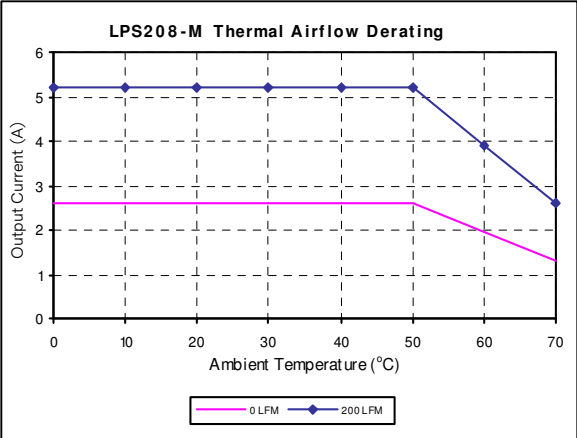

Figure 55: LPS208-M Derating Curves
 Vin = 115Vac Load: Io = 0 to 5.2A, I_{FAN} = 0A

ELECTRICAL SPECIFICATIONS

Protection Function Specifications

Input Fuse

LPS200-M series power supply is equipped with an internal non user serviceable 5A, 250 Vac for fault protection in both the 'line' and 'neutral' lines input.

Over Voltage Protection (OVP)

The power supply main Vo output will latch off during output overvoltage with the AC line recycled to reset the latch.

LPS202-M

Parameter	Min	Typ	Max	Unit
V _O Output Overvoltage	6.5	/	7.5	V

LPS203-M

Parameter	Min	Typ	Max	Unit
V _O Output Overvoltage	15.6	/	18.0	V

LPS204-M

Parameter	Min	Typ	Max	Unit
V _O Output Overvoltage	19.5	/	22.5	V

LPS205-M

Parameter	Min	Typ	Max	Unit
V _O Output Overvoltage	31.2	/	36.0	V

LPS208-M

Parameter	Min	Typ	Max	Unit
V _O Output Overvoltage	62.4	/	72.0	V

ELECTRICAL SPECIFICATIONS

Protection Function Specifications

Over Current Protection (OCP)

LPS200-M series power supply includes internal current limit circuitry to prevent damage in the event of overload or short circuit. In the event of overloads, the output voltage may deviate from the regulation band but recovery is automatic when the load is reduced to within specified limits.

LPS202-M

Parameter	Min	Typ	Max	Unit
V _O Output Overcurrent	44	/	64	A

LPS203-M

Parameter	Min	Typ	Max	Unit
V _O Output Overcurrent	22.88	/	33.28	A

LPS204-M

Parameter	Min	Typ	Max	Unit
V _O Output Overcurrent	18.337	/	26.672	A

LPS205-M

Parameter	Min	Typ	Max	Unit
V _O Output Overcurrent	11.44	/	16.64	A

LPS208-M

Parameter	Min	Typ	Max	Unit
V _O Output Overcurrent	5.72	/	8.32	A

Short Circuit Protection (SCP)

The power supply will withstand a continuous short circuit with no permanent damage. The power supply will automatically restart when the short circuit is removed. A short is defined as impedance less than 50 milliohms.

Over Temperature Protection (OTP)

The power supply latches off during over-temperature condition and returns back to normal operation when the power supply is cooled down. The LPS200-M series power supply might experience over-temperature conditions during a persistent overload on the output. Overload conditions can be caused by external faults. OTP might also be entered due to a loss of control of the environmental conditions e.g. an increase in the converter's ambient temperature due to a failing fan or external cooling system etc.

MECHANICAL SPECIFICATIONS

Mechanical Outlines (Dimensioning and Mounting Locations)

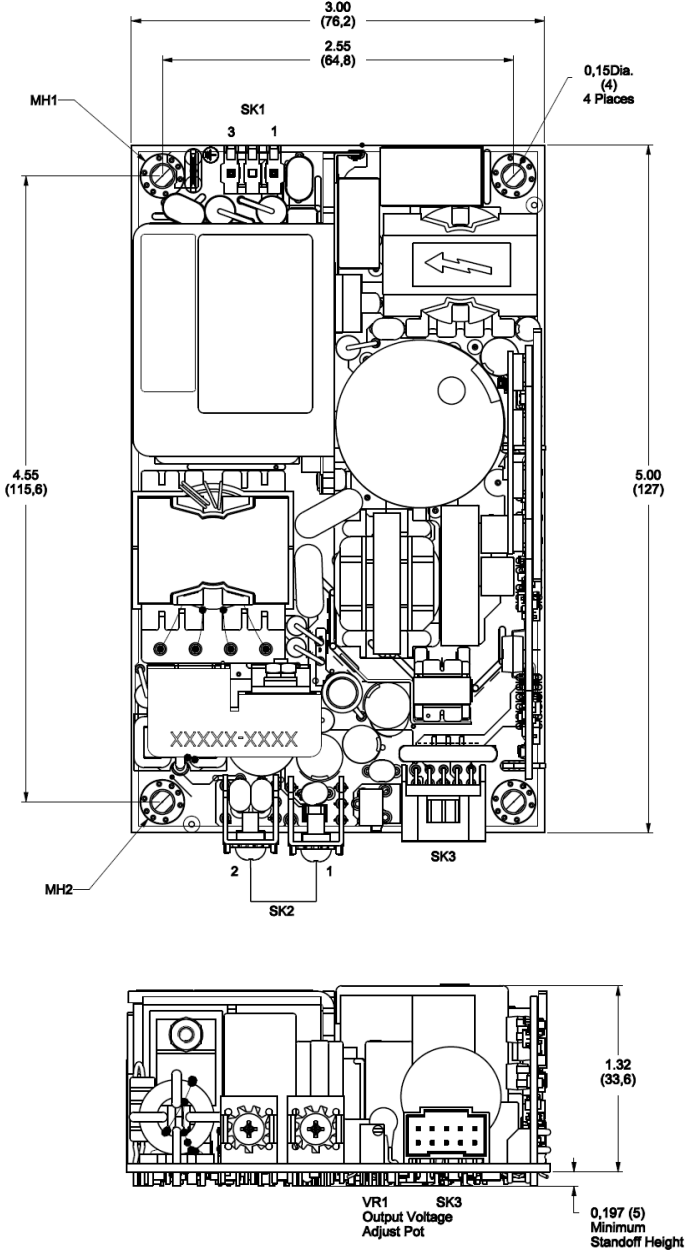

- All dimensions in inches [mm], tolerance is +/-0.02" [0.5mm]
- Mounting holes M1 and M2 should be grounded for EMI purpose
- Mounting hole M1 is safety ground connection
- Requires mounting on standoffs 0.20" [5.0mm] in height

MECHANICAL SPECIFICATIONS

Connector Definitions

AC Input Connector – SK1

Pin 1 - Neutral

Pin 3 - Line

Earth Ground - GND

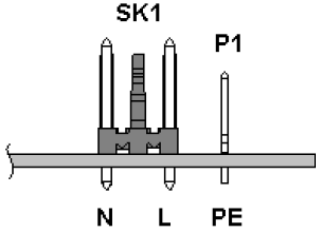

Output Connector – SK2

TB-1 – Common

TB-2 – Main output

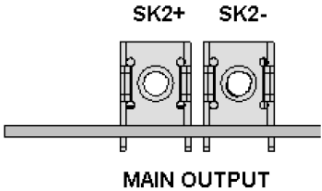

Control Signal Header - SK3

Pin 1 – + Remote Sense

Pin 2 – - Remote Sense

Pin 3 – N/C

Pin 4 – N/C

Pin 5 – Power Fail

Pin 6 – Common

Pin 7 – N/C

Pin 8 – Common

Pin 9 – +12V FAN

Pin 10 – + 12V FAN Return (isolated)¹

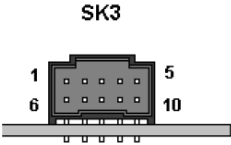

Note 1 - FAN Return is isolated from the main Output Return

Note 2 - Recommended Screw Torque for SK2 terminal (M3.5 X 0.6P) = 6-8 Kgf-cm

MECHANICAL SPECIFICATIONS

Power / Signal Mating Connectors and Pin Types

Table 4. Mating Connectors for LPS200-M Series

Reference	Vendor	Mating Connector or Equivalent	Mating Pins/Terminals or Equivalent
SK1	Molex	09-50-8031	08-52-0113
	Landwin	3060S0302	3360T011P
GND	Molex	01-90020001	
SK2	Molex	01-90990044	
SK3	Molex	90142-0010	90119-2110
	AMP	87977-3	87309-8

LPS200-M connector kit can be ordered separately. Connector Kit #: 70-841-020.

A LPS200-M connector kit contains the following:

- 1pcs Molex 09-50-8031 header housing for SK1
- 4pcs Molex 08-52-0113 crimp pins for Molex 09-50-8031
- 1pcs Molex 01-90020001 insulated female lug for GND
- 2pcs Molex 01-90990044 insulated snap spade terminals for SK2
- 1pcs Molex 90142-0010 header housing for SK5
- 12pcs Molex 90119-2110 crimp pins for Molex 90142-0010

MECHANICAL SPECIFICATIONS

Weight

The LPS200-M series weight is 0.75lb / 340g maximum.

ENVIRONMENTAL SPECIFICATIONS

EMC Immunity

LPS200-M series power supply is designed to meet the following EMC immunity specifications.

Table 5. Environmental Specifications	
Document	Description
FCC Part 15 Subpart J Class B/ EN55032, Level B	Conducted and Radiated EMI Limits
EN61000-3-2	Harmonics
IEC/EN 61000-4-2	Electromagnetic Compatibility (EMC) - Testing and measurement techniques – Electrostatic discharge immunity test. +/-8KV air, +/-4KV contact discharge, performance Criteria B
IEC/EN 61000-4-3	Electromagnetic Compatibility (EMC) - Testing and measurement techniques, Radiated, radio-frequency, electromagnetic field immunity test
IEC/EN 61000-4-4	Electromagnetic Compatibility (EMC) - Testing and measurement techniques, Electrical Fast Transient/Burst Immunity Test. 2KV for AC power port, 1.0KV for DC ports, I/O and signal ports performance Criteria B
IEC/EN 61000-4-5	Electromagnetic Compatibility (EMC) - Testing and measurement techniques – 2KV common mode and 1KV differential mode for AC ports and 0.5kV differential mode for DC power, I/O and signal ports, performance criteria B.
IEC/EN 61000-4-6	Electromagnetic Compatibility (EMC) - Testing and measurement techniques - Radio frequency common mode, Levels 3V (rms) Modulated AM 80%.
IEC/EN 61000-4-8	Electromagnetic Compatibility (EMC) - Testing and measurement techniques : Power Frequency Magnetic Immunity, 1 A/m.

ENVIRONMENTAL SPECIFICATIONS

Safety Certifications

The LPS200-M series power supply is intended for inclusion in other equipment and the installer must ensure that it is in compliance with all the requirements of the end application. This product is only for inclusion by professional installers within other equipment and must not be operated as a stand alone product.

Table 6. Safety Certifications for LPS200-M Series Power Supply System	
Standard	Description
UL 62368-1	US and Canada Requirements
CSA 22.2 No. 62368-1	Information Technology Equipment - Safety - Part 1: General Requirements (Bi-National standard, with UL 60950-1)
EN62368-1	European Requirements
CB Certificate and Report	(All CENELEC Countries)

ENVIRONMENTAL SPECIFICATIONS

EMI Emissions

The LPS200-M series has been designed to comply with the Class B limits of EMI requirements of EN55032 (FCC Part 15) and CISPR 22 (EN55032) for emissions and relevant sections of EN61000 (IEC 61000) for immunity.

The unit is enclosed inside a metal box, tested at 150W using resistive load with cooling fan.

Conducted Emissions

The applicable standard for conducted emissions is EN55032 (FCC Part 15). Conducted noise can appear as both differential mode and common mode noise currents. Differential mode noise is measured between the two input lines, with the major components occurring at the supply fundamental switching frequency and its harmonics. Common mode noise, a contributor to both radiated emissions and input conducted emissions, is measured between the input lines and system ground and can be broadband in nature.

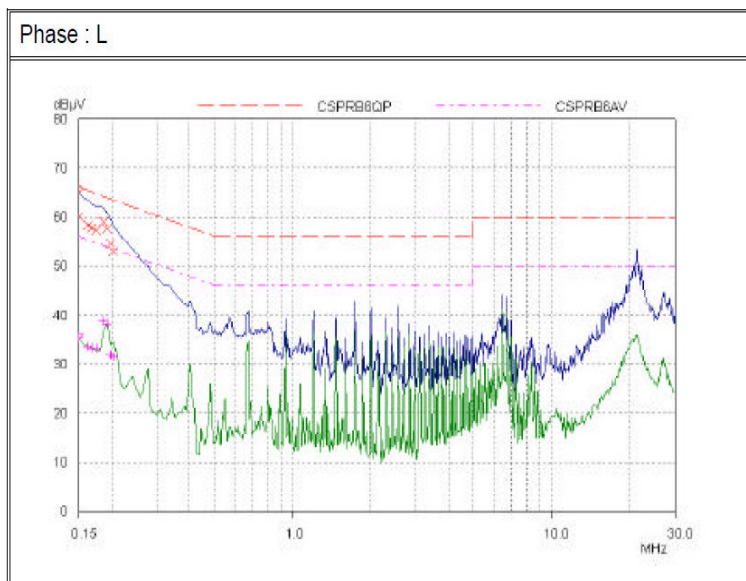

The LPS200-M series power supply have internal EMI filters to ensure the convertor's conducted EMI levels comply with EN55032 (FCC Part 15) Class B and EN55032 (CISPR 22) Class B limits. The EMI measurements are performed with resistive loads under forced air convection at maximum rated loading.

Sample of EN55032 Conducted EMI Measurement at 100Vac input

Note: Orange Line refers to Advanced Energy Quasi Peak margin, which is 6dB below the CISPR international limit. Pink Line refers to Advanced Energy Average margin, which is 6dB below the CISPR international limit.

Conducted EMI emissions specifications of the LPS200-M series:

Parameter	Model	Symbol	Min	Typ	Max	Unit
FCC Part 15, class B	All	Margin	6	-	-	dB
CISPR 22 (EN55032) class B	All	Margin	6	-	-	dB
EN 60601-1-2: 2001	All	Margin	6	-	-	dB
VCCI Class II	All	Margin	6	-	-	dB

Radiated Emissions

Unlike conducted EMI, radiated EMI performance in a system environment may differ drastically from that in a stand-alone power supply. The shielding effect provided by the system enclosure may bring the EMI level from Class A to Class B. It is thus recommended that radiated EMI be evaluated in a system environment. The applicable standard is EN55022 Class A (FCC Part 15). Testing ac-dc convertors as a stand-alone component to the exact requirements of EN55022 can be difficult, because the standard calls for 1m leads to be attached to the input and outputs and aligned such as to maximize the disturbance. In such a set-up, it is possible to form a perfect dipole antenna that very few ac-dc convertors could pass. However, the standard also states that 'an attempt should be made to maximize the disturbance consistent with the typical application by varying the configuration of the test sample'.

ENVIRONMENTAL SPECIFICATIONS

The LPS200-M series power supply is designed to meet all of its specifications during any combination of operating ambient conditions and after exposure to any combination of non-operating ambient conditions specified in this section.

Table 7. Maximum Ambient Conditions						
Parameter	Model	Symbol	Min	Typ	Max	Unit
Ambient Operating Temperature	All	T _A	0	-	+70 ¹	°C
Cold Start-up Temperature	All	T _{ST}	-20	-	-	°C
Storage Temperature	All	T _{STG}	-40	-	+85	°C
Shock Operating	All	Accordance to IEC 68-2-27 Three positive and negative pulses in each axis 30G, half sine, 11mSec duration				
Vibration		Accordance to IEC 68-2-6 to levels IEC 721-3-2 Tested in three mutually perpendicular axes				
MTBF Forced air 25°C	All	At nominal input lines >550,000hrs				

Note 1 - Derate each output at 2.5% per degree C from 50°C to 70°C.

POWER AND CONTROL SIGNAL DESCRIPTIONS

AC Input (SK1)

This connector supplies the AC Mains to the LPS200-M series power supply.

Pin 1 - Neutral

Pin 3 - Line

Earth Ground (GND)

This tab connector is the safety ground connection and should be connected to AC input earth ground.

GND - Earth Ground (Safety Ground)

Main Output (SK2)

These terminals provide the main output for the LPS200-M.

TB-1 - Common

TB-2 - Main output

Vo Output voltage adjustment

The main output of the LPS200-M series power supply can be adjusted by +/- 10% from its nominal output voltage via the potentiometer VR1. Since the 12V Fan Supply is not independently regulated, its output voltage may change according to Vo set point.

10-Pin header connector (SK3)

The LPS200-M series power supply contains an isolated 12V output for powering a cooling fan or as a aux power source. This 12V Fan Supply is provided by pin9/pin10 of header connector SK3.

Pin 1 - +Remote Sense

Pin 2 - -Remote Sense

Pin 3 - NC

Pin 4 - NC

Pin 5 - Power Fail

Pin 6 - Common

Pin 7 - NC

Pin 8 - Common

Pin 9 - +12V Fan

Pin 10 - -12V Fan Return

POWER AND CONTROL SIGNAL DESCRIPTIONS

Power Fail - (SK3 - Pin 5)

Power Fail is an open emitter output capable of sinking 10ma maximum at 0.9VDC. This signal is referenced to Output Return. Add a pull-up resistor (10K) to an external supply (12V max) for the Power Fail signal.

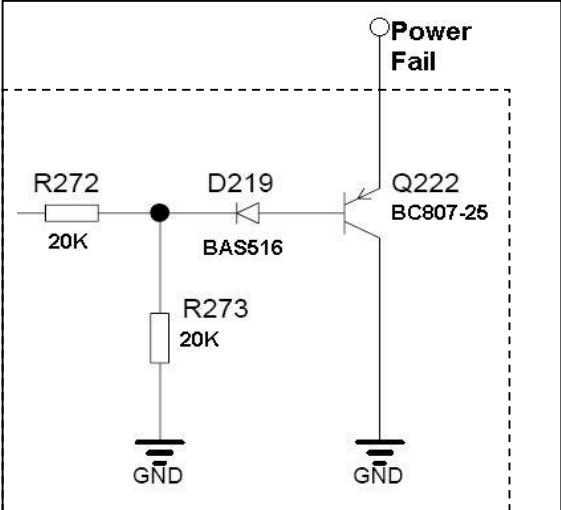

Power Fail signal output equivalent circuit

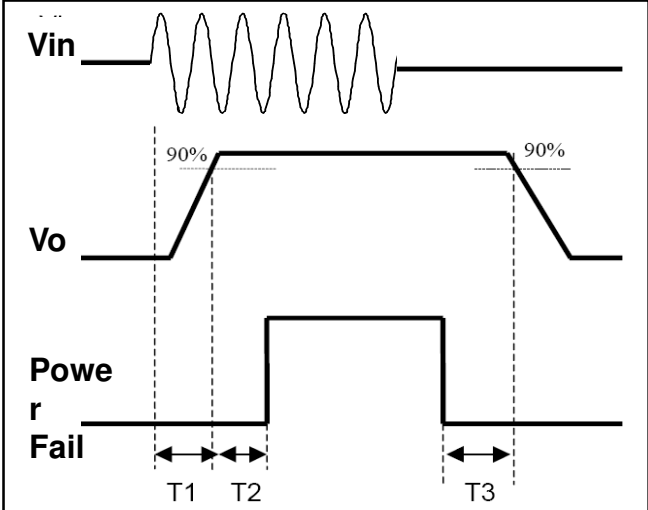

Power Fail signal timing diagram

Low to High Transition (Power OK)

Mains AC Application - Delay time measurement between the application of the Mains AC at the power supply input to the availability of the regulated Vo – T1 (Turn On Delay) and the delay time T2 to when Power Fail signal indicates output voltage Vo is OK. AC line should be considered at 0 degrees at time of initial application to the AC input.

High to Low Transition (Power Fail)

Loss of Main AC - The high to low transition of the Power Fail signal shall be an indication of the impending loss of Vo regulation due to a shutdown condition such as the loss of Mains AC, Overvoltage Protection or Over Temperature Protection. The AC line should be considered at 0 degrees at the time of removal from the power supply input.

Table 8. Timing specifications of the Power Fail signal

Parameter	Conditions	Symbol	Min	Typ	Max	Unit
Turn On Delay	$V_{IN,AC} = 90 \text{ Vac}$ $P_O = P_{O,maxFA}$	T1	-	-	2	Sec
Power OK Delay	$V_{IN,AC} = 115 \text{ Vac}$ $P_O = P_{O,maxFA}$	T2	100	-	500	mSec
Power Fail Delay	$V_{IN,AC} = 115 \text{ Vac}$ $P_O = P_{O,maxFA}$	T3	6	-	-	mSec

POWER AND CONTROL SIGNAL DESCRIPTIONS

+Remote Sense, -Remote Sense (Remote Sensing) – (SK3 – Pin 1 and Pin 2)

The main output of the LPS200-M series power supply is equipped with a Remote Sensing capability that will compensate for a voltage drop of up to a 0.5V between the output terminals of the supply and the sensed voltage point (load). This feature is implemented by connecting the Vo +Remote Sense (pin 1) and the Vo -Remote Sense (pin 2) terminals to the positive and negative rails of the main output, respectively, at a location that is near to the load. Care should be taken in the routing of the sense lines as any noise sources or additional filtering components introduced into the voltage rail may affect the stability of the power supply. The LPS200-M series power supply will operate appropriately without the sense lines connected; however it is recommended that the sense lines be connected directly to the main output terminals if remote sensing is not required.

The power supply is protected against damage caused by inadvertent reverse connection of the Remote Sense lines.

Remote sensing has no effect on the +12V FAN output.

Note: The maximum output voltage of the LPS200-M series power supply is limited to +10% above the nominal setting, trimming the main output above the nominal may limit the maximum amount of voltage sense compensation.

APPLICATION NOTES

Output Ripple and Noise Measurement

The setup outlined in the diagram below has been used for output voltage ripple and noise measurements on the LPS200-M series. When measuring output ripple and noise, a scope jack in parallel with a 0.1uF ceramic chip capacitor, and a 10 uF aluminum electrolytic capacitor should be used. Oscilloscope should be set to 20 MHz bandwidth for this measurement.

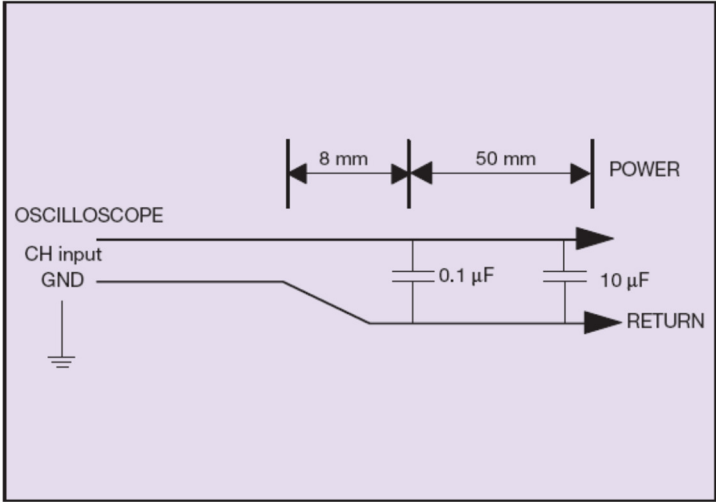

Block Diagram

Below is the block diagram of the LPS200-M series power supply.

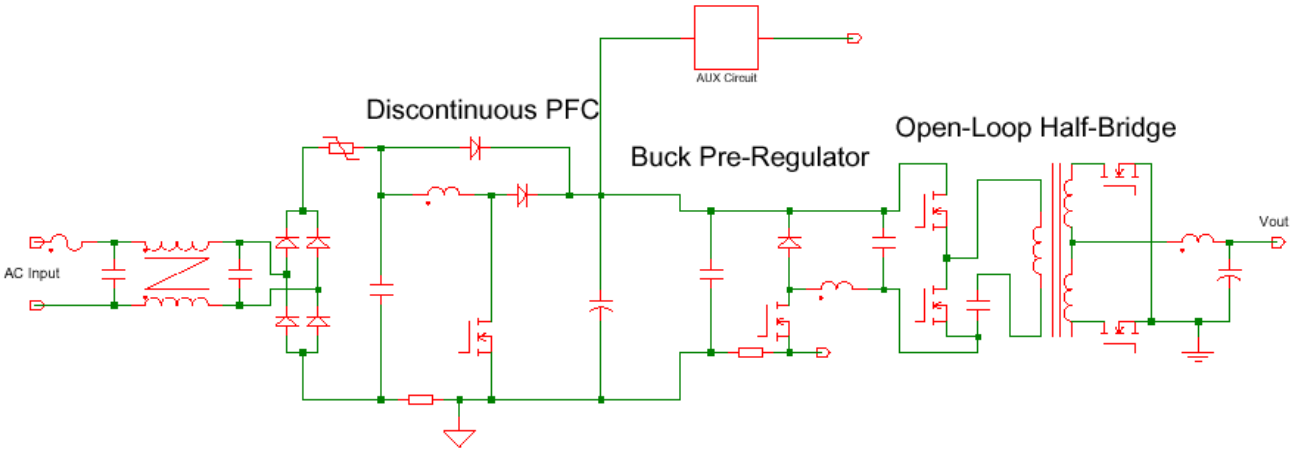

RECORD OF REVISION AND CHANGES

Issue	Date	Description	Originators
1.1	10.17.2011	First Issue	J. Zhu
1.2	10.02.2014	Update thermal derating curve	K. Wang
1.3	09.23.2015	Add "Input AC /DC Under Voltage Lockout Voltage" in Table 2	K. Wang
1.4	10.28.2015	Change the word "Emerson" to "Artesyn"	K. Wang
1.5	12.13.2016	Update the weight information	K. Wang
1.6	03.15.2017	Add the recommended screw torque	K. Wang
1.7	06.12.2017	Update the OCP format	K. Wang
1.8	06.18.2020	Update safety cert from 60950 to 62368	K. Wang
1.9	12.10.2020	Update pin definition for fan Return	K. Wang



For international contact information,
visit advancedenergy.com.

powersales@aei.com (Sales Support)
productsupport.ep@aei.com (Technical Support)
+1 888 412 7832

ABOUT ADVANCED ENERGY

Advanced Energy (AE) has devoted more than three decades to perfecting power for its global customers. AE designs and manufactures highly engineered, precision power conversion, measurement and control solutions for mission-critical applications and processes.

Our products enable customer innovation in complex applications for a wide range of industries including semiconductor equipment, industrial, manufacturing, telecommunications, data center computing, and medical. With deep applications know-how and responsive service and support across the globe, we build collaborative partnerships to meet rapid technological developments, propel growth for our customers, and innovate the future of power.

PRECISION | POWER | PERFORMANCE

Specifications are subject to change without notice. Not responsible for errors or omissions. ©2020 Advanced Energy Industries, Inc. All rights reserved. Advanced Energy®, and AE® are U.S. trademarks of Advanced Energy Industries, Inc.